



Dynamic Engineers, Inc.

# Products Brochure Frequency Control Solutions

**OCXO**

**TCXO**

**XO**

**VCXO**

**Custom GHz Frequency Source Module**

**Custom Crystal Filter**

**Custom LC Filter Module**

**Custom SMD VCO Device**

[www.DynamicEngineers.com](http://www.DynamicEngineers.com)

## World Class Supplier of Frequency Control Technology

Since 1986, Dynamic Engineers Inc. of Houston, Texas, has been supplying global customers with tailored solutions to their RF component requirements. We have design engineers with the right experience to customize standard product designs to meet special functional parameters.

### Areas of Expertise:

- **OCXO : Oven Controlled Crystal Oscillators**
  - Low Phase Noise Oscillators
  - Miniature high performance Ovenized Oscillators
  - Ultra-stable Double Ovens
- **TCXO : Temperature Compensated Crystal Oscillators**
  - Ultra-stability
- **VCXO : Voltage Controlled Crystal Oscillators**
- **XO : Crystal Clock Oscillators**
- **LC Filters**
- **Tunable Filter Modules**
- **VCO : Voltage Controlled Oscillators**

### Focus Applications

- **SATCOM**
- **Mobile Communications**
- **Test Instrumentation**

## Quality and Customer Service

Dynamic Engineers utilizes its comprehensive industry experience to transform general customer requirements into highly reliable, cost effective Frequency Control Solutions, with 100% support through the entire product life cycle from proto-type stage until end of life.

## Export Control Compliance

Dynamic Engineers uses a well-established internal document control system to monitor our compliance with the U.S. Export Administration Regulations.



# Basic Radio Architecture

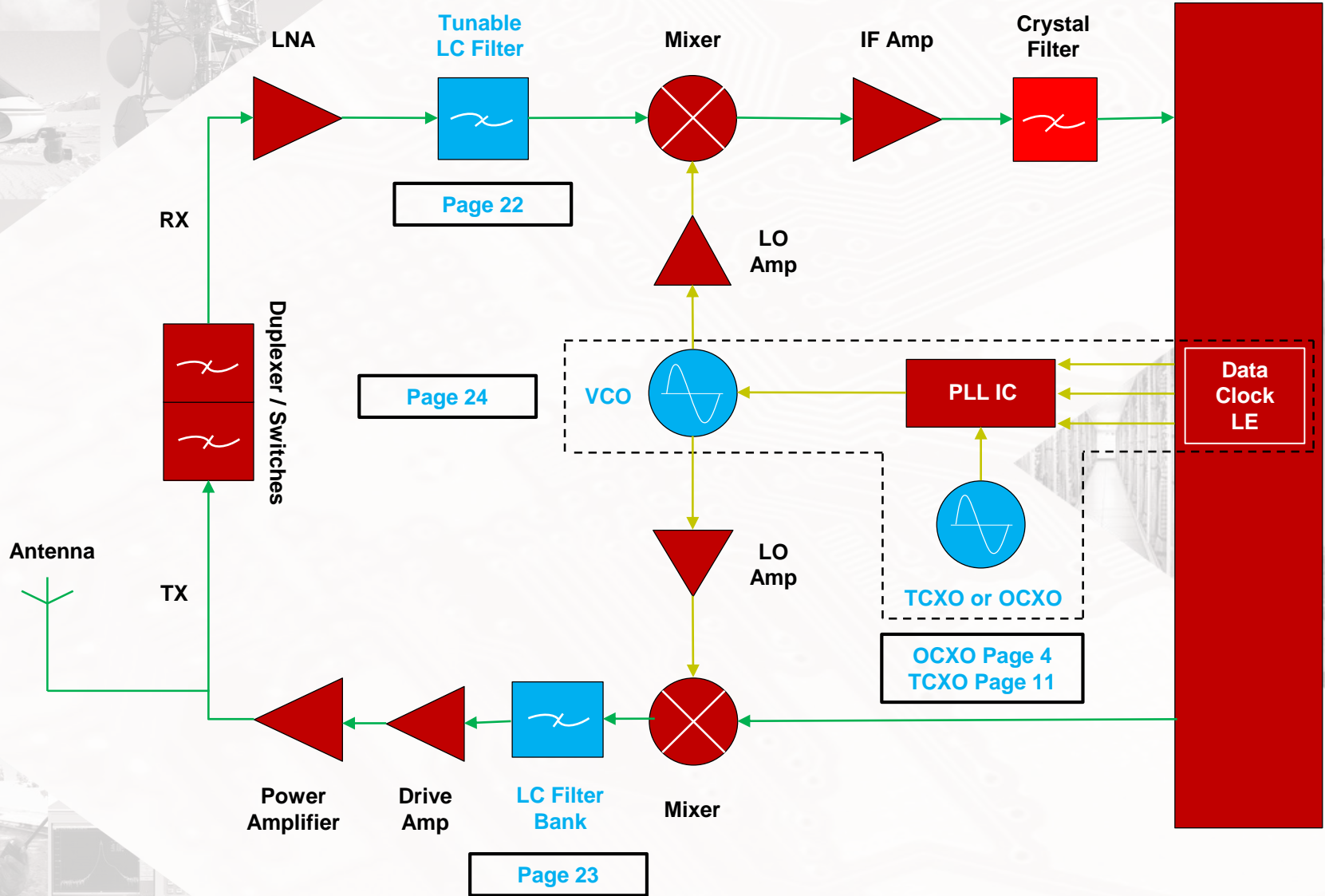

Devices highlighted in blue can be provided by Dynamic Engineers.



Dynamic Engineers, Inc.  
**Radio Diagram**

**CONTACT US :**  
[www.DynamicEngineers.com](http://www.DynamicEngineers.com)  
[Sales@DynamicEngineers.com](mailto:Sales@DynamicEngineers.com)  
 TEL: (+1) 281-870-8822

## OCXO : Oven Controlled Crystal Oscillator

4

- Vibration Isolated OCXO
- Ultra Low Power Miniature OCXO
- Low Profile Miniature OCXO (8 mm Max Height)
- Extreme Low Temperature Miniature OCXO (-60°C)
- Extreme High Temperature OCXO +130°C
- Ultra-Stable DOCXO
- Ultra-Low Phase Noise OCXO (10 to 120 MHz)
- Superior Allan Deviation OCXO
- High Performance SMD OCXO
- High Performance 500 MHz OCXO
- Expanded Selection of Standard Package OCXO

## TCXO : Temperature Compensated Crystal Oscillator

11

- Satellite Communication SMD TCXO
  - BeiDou, GPS, Galileo
- High Stability Miniature SMD TCXO
- New Generation High Stability 0.1 ppm SMD TCXO
- Next Generation 5G Reference Oscillator Solutions
- Extended Temperature TCXO (-55 to +105°C)
  - Expanded Selection of SATCOM ET TCXO
- 10 to 1450 MHz Quick Delivery VCTCXO (Size: 2.5x3.2 mm)
- 10 to 1450 MHz Quick Delivery VCTCXO (Size: 5x7 mm)
- Low-G SATCOM TCXO (Less than 0.5 ppb/G)
- Ultra High Stability TCXO (Dual Compensation Process)
- Expanded Selection of Large Package TCXO to 800 MHz

## XO : Crystal Clock Oscillator

17

- Extended Temperature Range XO (-55 to +125°C)
- Extreme Temperature XO (-100 to +300°C)
- Lowest Jitter XO  
(Integrated Phase Jitter in Femto-seconds)
- Expanded Selection of Standard Package XO

## VCXO : Voltage Control Crystal Oscillators

19

- Lowest Jitter VCXO (frequency: Up to 2.1 GHz)
- SMA Output Connector VCXO
- Expanded Selection of Standard Package VCXO

## Custom GHz Frequency Source Modules

20

- Multiple Phase Coherent Outputs
- GHz Single Output TCXOs

## Custom LC Filter Modules

22

- Custom LC Filter Design (frequency: Up to 6 GHz)
- Tunable LC Filters (frequency: 225MHz – 512MHz)
- Filter Banks (frequency: 30MHz – 512MHz)

## VCO: Voltage Controlled Oscillators

24

- Product Table of VCO Design Capability



## Vibration Isolated OCXO : Oven Controlled Crystal Oscillator

Dynamic Engineers' state-of-the-art vibration isolated OCXO5050L-100MHz-C-V features a 100MHz SC-cut crystal that is impedance matched to the oscillator and amplifier circuits to deliver ultra low phase noise under rugged environment our specially designed vibration isolated enclosure.

- **Stationary Phase Noise:**
  - 132 dBc/Hz at 100Hz offset
  - 163 dBc/Hz at 1000Hz offset
- **Under Vibration Phase Noise:**
  - 100 dBc/Hz at 100Hz offset
  - 170 dBc/Hz at 1000Hz offset
- Frequency Range: 100MHz
- Voltage range: 10V to 15V
- Output: 50 Ohm Sine Wave
- Stability:  $\pm 100$  ppb
- Temperature range: -55 to +85°C
- Available with SMA connector

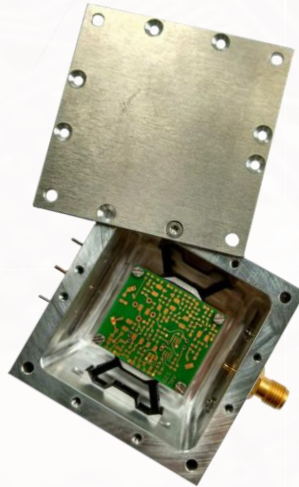

OCXO5050L-100MHz-C-V  
Expected phase noise under vibration for worst axis

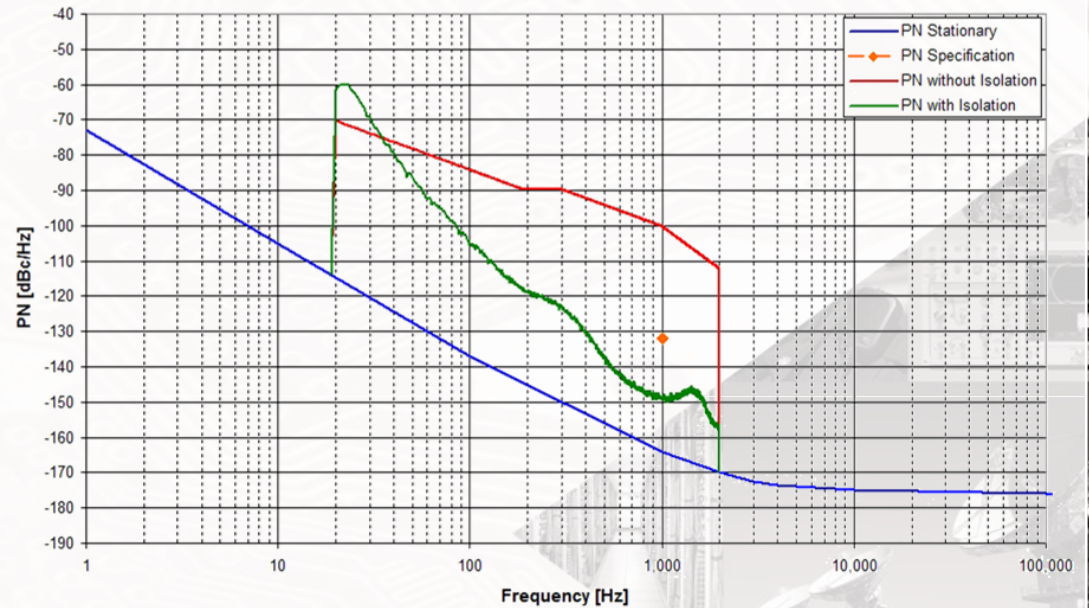

Model	Package (mm)	Phase Noise (typ.)	Vibration	Comments
OCXO5050L-100MHz-C-V	50 x 50 x 30	<p><b>At Rest</b></p> <ul style="list-style-type: none"> <li>-132 @ 100Hz</li> <li>-163 @ 1KHz</li> <li>-175 @ <math>\geq 10</math>KHz</li> </ul> <p><b>Under Random Vibration</b></p> <ul style="list-style-type: none"> <li>-100 @ 100Hz</li> <li>-145 @ 1KHz</li> <li>-170 @ 10KHz</li> </ul>	<p>Vibration 1: Random test without powering the OCXO 50~100 Hz, 1000~2000 Hz, tolerance: <math>\pm 1.5</math> dB.</p> <p>Vibration 2: Vibration test when OCXO powered Test in 3 directions X/Y/Z Axes, each test lasts 1hr 20~300Hz, 1000~2000Hz, tolerance: <math>\pm 1.5</math>dB</p>	<p>Please consult DEI for specific random vibration profile that the device under test is exposed to.</p> <p>Specific customer random vibration profiles will influence the shape of the GREEN vibration compensated dynamic phase noise performance.</p> <p>80 and 120 MHz operating frequencies are also considered standard products in this family.</p>



Dynamic Engineers, Inc.  
**OCXO : Oven Controlled**

**CONTACT US :**  
www.DynamicEngineers.com  
Sales@DynamicEngineers.com  
TEL: (+1) 281-870-8822

# Ultra Low Power Miniature OCXO : Oven Controlled Crystal Oscillator

Dynamic Engineers continues to enhance our miniature OCXO product platform in the critical areas of frequency stability over temperature, long term aging, and phase noise performance in stages of incremental improvements.

- Warm-up in 15 to 30 seconds with five times less turn-on power than traditional OCXO's in DIP14 compatible footprints
- Better than -170 dBc/Hz phase noise
- $\pm 20$  ppb frequency stability can be maintained all the way down to  $-60^{\circ}\text{C}$ .
- An 8 mm maximum height profile miniature package option is available.

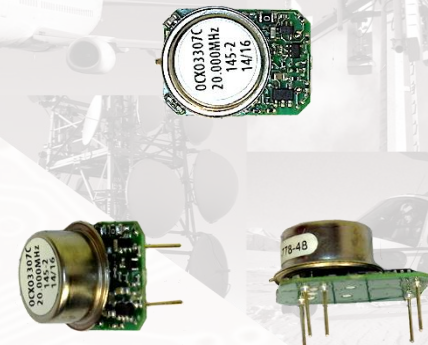

Model	Power Supply	Output Type	Frequency Range (MHz)	Frequency Stability (ppb)	Operating Temperature Range ( $^{\circ}\text{C}$ )	Package (mm)
OCXO3305	3.3, 5	CMOS or Sine	5 to 250	20	-40 to +80	15.1 x 20.5 x 10
OCXO3305C	3.3, 5	CMOS or Sine	8 to 150	5	-40 to +85	15.1 x 20.5 x 10
OCXO3306C	3.3, 5	CMOS or Sine	8 to 120	50	-40 to +85	15.1 x 20.5 x 10
OCXO3307C-ET	3.3, 5	CMOS or Sine	8 to 150	20	$-60$ to +85	15.1 x 20.5 x 10
OCXO3308C	3.3, 5	CMOS or Sine	8 to 150	3	-40 to +85	15.1 x 20.5 x 10
OCXO3309	3.3, 5	CMOS or Sine	8 to 100	50	-40 to +85	15.1 x 15.9 x 10
OCXO3309C	3.3, 5	CMOS or Sine	8 to 150	5	-40 to +85	15.1 x 20.5 x 10
OCXO3310C	3.3, 5	CMOS or Sine	8 to 100	5	-40 to +85	15.1 x 15.9 x 10
OCXO3311C	3.3, 5	CMOS or Sine	8 to 100	50	-40 to +85	15.1 x 15.9 x 10
OCXO3312C	3.3, 5	CMOS or Sine	8 to 150	5	-40 to +85	15.1 x 15.9 x 8.8
OCXO3313C	3.3, 5	CMOS or Sine	8 to 150	5	-40 to +85	15.1 x 15.9 x 8.8
OCXO3314C	3.3, 5	CMOS or Sine	8 to 100	5	-40 to +85	15.1 x 15.9 x 10

The Best Stability Available is a Function of Operating Temperature Range

Daily Aging of  $\pm 0.2$  ppb per day

Fast Warm-Up (15 to 60 seconds depending on the coldest operating temperature and maximum turn-on power)

## Extended Temperature High Stability OCXO : Oven Controlled Crystal Oscillator ( $-55^{\circ}\text{C}$ to $+100^{\circ}\text{C}$ )

OCXO2020AW-10MHz-B-V (Extended temperature high stability)

The OCXO2020AW-10MHz-B-V extended temperature high stability OCXO offers superior (up to  $\pm 5$  ppb) frequency stability under extended operating temperature conditions between  $-55^{\circ}\text{C}$  to  $+100^{\circ}\text{C}$ .

- $\pm 5$  ppb Frequency Stability
- $-55^{\circ}\text{C}$  to  $+100^{\circ}\text{C}$  extended operating temperature
- Low aging rate:  $\pm 0.2$  ppb / day,  $\pm 0.02$  ppm / year
- Low phase noise ( $-168$  dBc/Hz floor at 100MHz)



Dynamic Engineers, Inc.

**OCXO : Oven Controlled**

CONTACT US :

www.DynamicEngineers.com  
Sales@DynamicEngineers.com  
TEL: (+1) 281-870-8822

## Low Profile Miniature OCXO : Oven Controlled Crystal Oscillator (8 mm Max Height)

### OCXO3306C (Height: 8.0 mm low profile)

The OCXO3306C series low profile miniature OCXO offers a wide frequency range, outstanding frequency stability and low phase noise performance, all with very fast warm-up and low power consumption in an 8.0 mm low profile design.

- Wide Frequency Range 8 to 150 MHz
- Frequency Stability less than or equal to 3 ppb
- Very low profile (as low as **8 mm** height packaging)
- Low power consumption (to 0.15W at +25°C)
- Low phase noise (-170 dBc/Hz floor at 100MHz)
- **Fast warm-up (15 to 30 seconds)**



## Extreme Low Temperature Miniature OCXO : Oven Controlled Crystal Oscillator (-60°C)

### OCXO3307C-ET (Height: 9.5 mm and down to -60°C operating temperature)

The OCXO3307C-ET extreme low temperature miniature OCXO incorporates internal heating resonator technology with the entire oven control mechanical structure packaged inside the TO-8 vacuum holder. This design offers a drastic reduction in volume, power consumption, and warm-up time while still maintaining outstanding frequency stability and phase noise performance normally associated with devices in much larger enclosures, yet allows the OCXO to operate at extreme cold temperature of -60°C.

- Low power consumption (less than 0.18 Watts typ. at +25°C after 60 second warm up)
- Less than  $\pm 20$  ppb over -60 to +85°C at 10 MHz
- Less than  $\pm 30$  ppb per year aging at 10 MHz
- 9.3 mm max. height

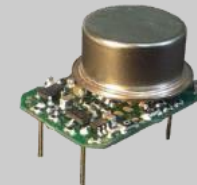

## Extreme High Temperature OCXO : Oven Controlled Crystal Oscillator **+130°C**

Dynamic Engineers' remarkable Extreme Temperature OCXO, the ETOCXO2020C-10MHz-A-V, features ambient temperatures reaching as high as **+130°C**. Exclusive high temperature bonding materials and processing techniques allow this model to achieve ultra-stable output and superior long term reliability at extreme temperatures.

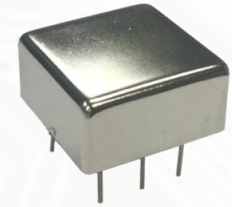

- Stability:  $\pm 10$  ppb over -40 to **+130°C**
- Low Phase Noise: -170 dBc/Hz @ 100 kHz
- Low Aging:  $\pm 0.3$  ppb per day aging
- Frequency Range: 5 to 30 MHz
- Applications: Oil Drilling

## Ultra-Stable DOCXO : Double-Oven Controlled Crystal Oscillator

The DOCXO2020C ultra-stable DOCXO can achieve less than  $\pm 0.1$  ppb stability in a small 20 x 20 mm enclosure by taking advantage of proprietary advances in resonator heating processes, which allow for a significant reduction in the oven-control thermal mass structure. As a result the Dynamic Engineer's DOCXO draws 50% less power than traditional designs offered by competitors in much larger product footprints (36 x 27 mm).



20 x 20 x 12.9 mm

### DOCXO2020C:

Frequency: 5 to 100 MHz

Frequency Stability:  $\pm 0.1$  ppb over -40 to +80°C

Aging:  $\pm 0.1$  ppb/day

Allan Variance:  $5 \times 10^{-12}$  /s

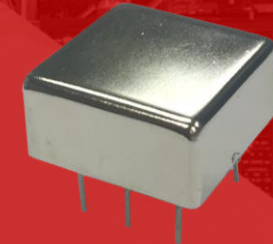

Dynamic Engineers, Inc.  
**OCXO : Oven Controlled**

**CONTACT US :**  
[www.DynamicEngineers.com](http://www.DynamicEngineers.com)  
[Sales@DynamicEngineers.com](mailto:Sales@DynamicEngineers.com)  
TEL: (+1) 281-870-8822



## Ultra-Low Phase Noise OCXO : Oven Controlled Crystal Oscillator : 10 to 120 MHz

The OCXO2525L-100MHz-LG-XX ultra low phase noise OCXO delivers instrument grade performance with:

- Less than -160 dBc/Hz @ 1 KHz offset
- +13 dBm min. ultra low noise sine wave output
- $\pm 100$  ppb max stability from 0°C to +80°C
- Low-G sensitivity options available

### Typical Noise for OCXO2525L-100MHz-LG-XX @ 100 MHz Operating Frequency

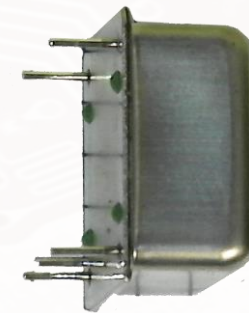
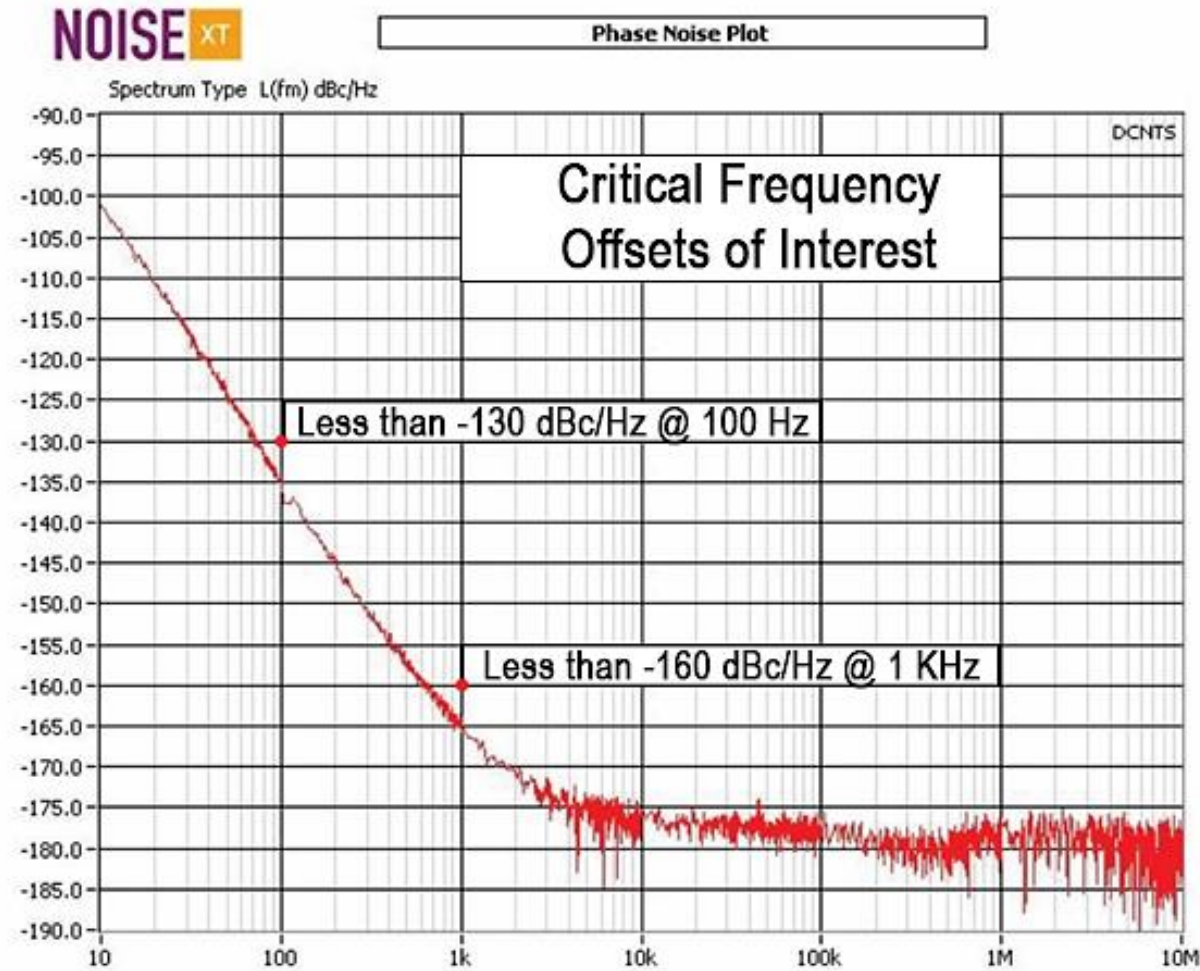

Dynamic Engineers, Inc.  
**OCXO : Oven Controlled**

**CONTACT US :**  
[www.DynamicEngineers.com](http://www.DynamicEngineers.com)  
[Sales@DynamicEngineers.com](mailto:Sales@DynamicEngineers.com)  
TEL: (+1) 281-870-8822

## Superior Allan Deviation OCXO : Oven Controlled Crystal Oscillator

Dynamic Engineers offers two OCXO products specially designed to deliver superior Allan deviation performance (short term stability) with a standard 10 MHz, low noise sine wave, and 12V power supply. Advanced low noise crystal processes are utilized to deliver outstanding 1 Hz to 100 Hz close-in phase noise which translates into world class Allan deviation performance. Applications demanding precise timing synchronization such as SATCOM ground stations, 4G-LTE networks, and high data rate digital modulation systems are ideal for these OCXOs.

Model	Device Type	Output Type	Allan Deviation (ppb) (for tau = 1 sec)	Frequency Stability (ppb) (-40 to +85°C)	Close In Noise (dBc/Hz)			Package (mm)
					1 Hz	10 Hz	100 Hz	
OCXO5050Z-10MHz-A-V	Low Phase Noise	Sine	0.0006	± 0.2	-108	-137	-157	50.8 x 50.8 x 16
OCXO3627L-10MHz	Low Phase Noise	Sine	0.002	± 25	-115	-146	-157	36.1 x 27.1 x 14

## High Performance SMD OCXO : Oven Controlled Crystal Oscillator

Dynamic Engineers offers a wide selection of high performance OCXO devices in surface mount packages. They range from 9 x 14 to 28 x 28 mm footprints. Operating frequencies covering 8 to 150 MHz can be obtained. Small cell 4G LTE infrastructure, SATCOM, mobile radio, and test instrumentation (synthesizer) clock references are all current applications being served by our surface mount OCXOs.

Model	Device Type	Power Supply	RF Output	Frequency Range (MHz)	Frequency Stability (ppb)	Operating Temperature (°C)	Package (mm)
OCXO2522L-10MHz	Standard	12	Sine	10	5	-20 to +70	22 x 25.4 x 14
OCXO2522LULN1	Extended Temp	12	Sine	100	5	-55 to +85	22 x 25.4 x 14
OCXO2522LULN2	Extended Temp	12	Sine	120	5	-55 to +85	22 x 25.4 x 14
OCXO2828LULN1	Extended Temp	12	Sine	100	5	-55 to +85	27.8 x 27.8 x 15.5
OCXO2828LULN2	Extended Temp	12	Sine	120	5	-55 to +85	27.8 x 27.8 x 15.5
OCXO1615C	Extended Temp	3.3 or 5.0	CMOS or Sine	8 to 150	10	-60 to +85	15.2 x 16 x 9.5
OCXO914S	Standard	3.3 or 5.0	CMOS	10 to 40	30	-40 to +85	9.3 x 14.3 x 6.5

## High Performance 500 MHz OCXO : Oven Controlled Crystal Oscillator

Dynamic Engineers offers a wide frequency range (48 to 500 MHz) OCXO family in an industry standard 25 x 25 mm leaded enclosure. As a special ordering option, the customer can obtain the 12.7 mm height version with an SMA connector attached to the center of the signal pin base assembly. Test instrumentation, cellular infrastructure, and communications are some markets currently served by this OCXO family.

Model	Device Type	Power Supply	RF Output	Frequency Range (MHz)	Frequency Stability (ppb)	Operating Temperature (°C)	Package (mm)
OCXO2525ZS-LN	Low Phase Noise	12	Sine	48 to 500	100	-40 to +70	25.8 x 25.8 x 10
OCXO2525Z-SMA	Low Phase Noise	12	Sine	48 to 500	100	-40 to +70	25.8 x 25.8 x 12.7



## High Performance 500 MHz OCXO : Oven Controlled Crystal Oscillator

Dynamic Engineers offers a wide frequency range (48 to 500 MHz) OCXO family in an industry standard 25 x 25 mm leaded enclosure. As a special ordering option, the customer can obtain the 12.7 mm height version with an SMA connector attached to the center of the signal pin base assembly. Test instrumentation, cellular infrastructure, and communications are some markets currently served by this OCXO family.

Model	Device Type	Power Supply	RF Output	Frequency Range (MHz)	Frequency Stability (ppb)	Operating Temperature (°C)	Package (mm)
OCXO2525ZS-LN	Low Phase Noise	12	Sine	48 to 500	100	-40 to +70	25.8 x 25.8 x 10
OCXO2525Z-SMA	Low Phase Noise	12	Sine	48 to 500	100	-40 to +70	25.8 x 25.8 x 12.7

## Expanded Selection of Standard OCXO : Oven Controlled Crystal Oscillator

Dynamic Engineers is pleased to offer an expanded selection of standard OCXO package and performance configurations with a broad range of parameters. Customers can also order special functions such as oven standby, and specify unique requirements for short-term stability, noise, and non-standard frequencies.

- Standard DIP enclosures
- 50 ohm sine output
- 36 x 27 mm Europack size
- $\pm 0.5$  ppb stability over temperature for various applications

Model	Device Type	Power Supply	RF Output	Frequency Range (MHz)	Frequency Stability (ppb)	Operating Temperature (°C)	Package (mm)
OCXO2013Z1	Standard	3.3	CMOS	10 to 52	200	-40 to +85	13.2 x 20.8 x 7.8
OCXO2013Z2	Standard	5	CMOS	10 to 52	200	-40 to +85	13.2 x 20.8 x 7.8
OCXO2013Z3	Standard	12	CMOS	10 to 52	200	-40 to +85	13.2 x 20.8 x 7.8
OCXO2013ZS1	Standard	3.3	Sine	10 to 60	200	-40 to +85	13.2 x 20.8 x 7.8
OCXO2013ZS2	Standard	5	Sine	10 to 60	200	-40 to +85	13.2 x 20.8 x 7.8
OCXO2013ZS3	Standard	12	Sine	10 to 60	200	-40 to +85	13.2 x 20.8 x 7.8
OCXO2020ZS1	Standard	5	Sine	8.192 to 20	3	-40 to +85	20 x 20 x 12.7
OCXO2020ZS2	Standard	12	Sine	8.192 to 20	3	-40 to +85	20 x 20 x 12.7
DOCXO3627Z	Double Oven	12	Sine	5 to 10	0.5	-40 to +70	27 x 36 x 19
OCXO3627Z-LG1	Low G	5	Sine	5 to 20	2	-40 to +85	27 x 36 x 16
OCXO3627Z-LG2	Low G	12	Sine	5 to 20	2	-40 to +85	27 x 36 x 16
OCXO3627Z-LN1	Low Phase Noise	5	Sine	48 to 120	100	-40 to +70	27 x 36 x 16
OCXO3627Z-LN2	Low Phase Noise	12	Sine	48 to 120	100	-40 to +70	27 x 36 x 16
OCXO2215LSQ1	Extended Temp	3.3	CMOS	10 to 125	5	-55 to +85	15.1 x 22.7 x 11
OCXO2215LSQ2	Extended Temp	5	CMOS	10 to 125	5	-55 to +85	15.1 x 22.7 x 11
OCXO2215LSQ3	Extended Temp	12	CMOS	10 to 125	5	-55 to +85	15.1 x 22.7 x 11
OCXO2215LS1	Extended Temp	3.3	Sine	10 to 125	5	-55 to +85	15.1 x 22.7 x 11
OCXO2215LS2	Extended Temp	5	Sine	10 to 125	5	-55 to +85	15.1 x 22.7 x 11
OCXO2215LS3	Extended Temp	12	Sine	10 to 125	5	-55 to +85	15.1 x 22.7 x 11



Dynamic Engineers, Inc.  
**OCXO : Oven Controlled**

## Satellite Communication SMD TCXO : Temperature Compensated Crystal Oscillator

Dynamic Engineers has devoted special focus to developing TCXOs specially optimized for global satellite system applications with outstanding performance. This enables our customers to meet the various requirements of BeiDou, GPS, and Galileo components and sub-systems.

- Less than 0.2 ppm frequency stability
- World class TCXO  $\pm 0.1$  ppb short term stability
- Excellent phase noise of less than -145 dBc/Hz @ 1 KHz

Model	Device Type	Power Supply	RF Output	Frequency Range (MHz)	Frequency Stability (ppm)	Operating Temperature (°C)	Package (mm)
TCXO7500ZCS1	SATCOM	3.3	Clipped Sine	10 to 25	0.1	-20 to +70	5 x 7 x 1.75
TCXO7500ZCS2	SATCOM	3.3	Clipped Sine	10 to 25	0.2	-40 to +85	5 x 7 x 1.75
TCXO7500ZSQ1	SATCOM	3.3	CMOS	10 to 25	0.1	-20 to +70	5 x 7 x 1.75
TCXO7500ZSQ2	SATCOM	3.3	CMOS	10 to 25	0.2	-40 to +85	5 x 7 x 1.75
TCXO5300ZCS1	SATCOM	3.3	Clipped Sine	10 to 25	0.1	-20 to +70	3.2 x 5 x 1.7
TCXO5300ZCS2	SATCOM	3.3	Clipped Sine	10 to 25	0.2	-40 to +85	3.2 x 5 x 1.7
TCXO5300ZSQ1	SATCOM	3.3	CMOS	10 to 25	0.1	-20 to +70	3.2 x 5 x 1.7
TCXO5300ZSQ2	SATCOM	3.3	CMOS	10 to 25	0.2	-40 to +85	3.2 x 5 x 1.7
TCXO7500ZCS3	Extended Temp	3.3	Clipped Sine	10 to 25	0.25	-40 to +95	5 x 7 x 1.75
TCXO7500ZSQ3	Extended Temp	3.3	CMOS	10 to 25	0.25	-40 to +95	5 x 7 x 1.75
TCXO5300ZCS3	Extended Temp	3.3	Clipped Sine	10 to 25	0.25	-40 to +95	3.2 x 5 x 1.7
TCXO5300ZSQ3	Extended Temp	3.3	CMOS	10 to 25	0.25	-40 to +95	3.2 x 5 x 1.7

Dynamic Engineers current list of qualified SATCOM TCXO's are listed below. These represent designs already incorporated in other generations of SATCOM device and sub-system development.

Model	Device Type	Power Supply	RF Output	Frequency Range (MHz)	Frequency Stability (ppm)	Operating Temperature (°C)	Package (mm)
TCXO3225T-10MHz-B-V	SATCOM	3.3	Clipped Sine	10	0.5	-40 to +85	2.5 x 3.2 SMD
TCXO5300Z-10MHz-A-V	Extended Temp	3.3	CMOS	10	1.0 (-55 to -40°C) 0.28 (-40 to +85°C)	-55 to +85	3.2 x 5.0 SMD
TCXO5300S-10MHz-A-V	SATCOM	3.3	Clipped Sine	10	0.28	-40 to +85	3.2 x 5.0 SMD
T5300TMP-16.32MHz-A	SATCOM	3.3	CMOS	16.32	0.5	-40 to +85	3.2 x 5.0 SMD
TCXO3403-10.000MHz-A	SATCOM	3.3	Clipped Sine	10	0.5	-40 to +85	5.0 x 7.0 SMD
TCXO7500T-10MHz-B	SATCOM	3.3	CMOS	10	0.5	-40 to +85	5.0 x 7.0 SMD



## High Stability Miniature SMD TCXO : Temperature Compensated Crystal Oscillator

This collection of high stability (up to 0.1 ppm) TCXO devices incorporates standard technology that customers can tailor to their specific requirements. These devices are currently being used in mobile radio and SATCOM modem applications with global customers.

Model	Device Type	Power Supply	RF Output	Frequency (MHz)	Frequency Stability (ppm)	Operating Temperature (°C)	Package (mm)
TCXO5300S-20MHz-A-V	High Stability	3.3	CMOS	20.000000	0.1	-25 to +70	3.2 x 5.0 SMD
TCXO5300THP-10MHz-D-V	High Stability	3.3	Clipped Sine	10.000000	0.28	-40 to +85	3.2 x 5.0 SMD
TCXO7500S-12.8MHz-A	High Stability	3.3	CMOS	12.800000	0.28	-40 to +85	5.0 x 7.0 SMD
TCXO7500T-10MHz-B	High Stability	3.3	CMOS	10.000000	0.5	-40 to +85	5.0 x 7.0 SMD
TCXO7500T-25.600MHz-A	High Stability	3.3	CMOS	25.600000	0.3	-40 to +75	5.0 x 7.0 SMD

## New Generation Ultra-Stability 0.1 ppm SMD TCXO : Temperature Compensated Crystal Oscillator

Dynamic Engineers has released a new generation of ultra-stable TCXOs designed to replace Oven Controlled Crystal Oscillators in high performance small cell LTE/4G or VSAT terminals. High performance mobile radio / manpacks are also ideal applications.

- Less than  $\pm 0.1$  ppm stability over -40 to +85°C
- Superior short-term stability of  $\pm 0.1$  ppb for  $\tau = 1$  second

Model	Device Type	Power Supply	RF Output	Frequency (MHz)	Frequency Stability (ppm)	Phase Noise at 10 KHz offset (dBc/Hz)	Package (mm)
TCXO5300Z-UHS-10.0MHz	Ultra-High Stability	3.3	Clipped Sine	10.0	0.1	-150	3.2 x 5
TCXO5300Z-UHS-19.2MHz	Ultra-High Stability	3.3	Clipped Sine	19.2	0.1	-145	3.2 x 5
TCXO5300Z-UHS-20.0MHz	Ultra-High Stability	3.3	Clipped Sine	20.0	0.1	-145	3.2 x 5
TCXO7500Z-UHS-20.0MHz	Ultra-High Stability	3.3	CMOS	20.0	0.1	-155	5 x 7
TCXO7500Z-UHS-28.8MHz	Ultra-High Stability	3.3	CMOS	28.8	0.1	-155	5 x 7



## Next Generation 5G Reference Oscillator Solutions TCXO

Dynamic Engineers is working with global telecom organizations to help define the requirements of the clock reference TCXO utilized in the transceiver section of the 5G base station. To date infrastructure designers have selected 40 and 51.2 MHz devices in their initial beta evaluation systems.

Model	Device Type	Power Supply	RF Output	Frequency (MHz)	Frequency Stability (ppm)	Operating Temperature (°C)	Package (mm)
<b>TCXO7500Z-40MHz-A-V</b>	Ultra-High Stability	3.3	CMOS	40	0.5	-40 to +85	5 x 7
<b>TCXO7500QC-51.2MHz-A-V</b>	Ultra-High Stability	3.3	CMOS	51.2	0.3	-40 to +85	5 x 7

## Extended Temperature TCXO : Temperature Compensated Crystal Oscillator (-55 to +105°C)

Dynamic Engineers extended temperature TCXOs utilize value-added compensation software to extend high stability beyond the traditional -40°C to +85°C industrial temperature range. Extending operation down to -55°C or up to +105°C typically requires careful control of crystal angle variation which influences the slope of the crystal curve at extreme operating temperatures.

Model	Device Type	Power Supply	RF Output	Frequency Range (MHz)	Frequency Stability (ppm)	Operating Temperature (°C)	Package (mm)
<b>TCXO7500S-ET</b>	Extended Temp	5.0	CMOS and Clipped Sine	5 to 52	2	-40 to +105	5.0 x 7.0
<b>TCXO7500S-ETZ-10MHz-A-V</b>	Extended Temp	3.3	Clipped Sine	10	0.8	-55 to +85	5.0 x 7.0
<b>TCXO7500S-ETZ-20MHz-A-V</b>	Extended Temp	3.3	Clipped Sine	20	0.8	-55 to +85	5.0 x 7.0
<b>TCXO7500ZCS3</b>	Extended Temp	3.3	Clipped Sine	10 to 25	0.25	-40 to +95	5.0 x 7.0
<b>TCXO7500ZSQ3</b>	Extended Temp	3.3	CMOS	10 to 25	0.25	-40 to +95	5.0 x 7.0
<b>TCXO5300ZCS3</b>	Extended Temp	3.3	Clipped Sine	10 to 25	0.25	-40 to +95	3.2 x 5.0
<b>TCXO5300ZSQ3</b>	Extended Temp	3.3	CMOS	10 to 25	0.25	-40 to +95	3.2 x 5.0



Dynamic Engineers, Inc.  
**TCXO : Temperature Compensated**

**CONTACT US :**  
[www.DynamicEngineers.com](http://www.DynamicEngineers.com)  
[Sales@DynamicEngineers.com](mailto:Sales@DynamicEngineers.com)  
 TEL: (+1) 281-870-8822

## 10 to 1450 MHz Quick Delivery VCTCXO (Size: 2.5 x 3.2 mm)



Dynamic Engineers miniature quick delivery VCTCXO can be delivered in 2-3 weeks for swift prototypes development in:

- Compact 2.5 x 3.2mm package
- Wide frequency range from 10 to 1450 MHz (up to 6<sup>th</sup> decimal place)
- CMOS, LVPECL or LVDS output

Model	Device Type	Power Supply	RF Output	Frequency Range (MHz)	Frequency Stability (ppm)	Operating Temperature (°C)	Package (mm)
TCXO3225R-2.5V-LVCMOS	Quick Delivery	2.5	CMOS	10 to 1450	1	-40 to +85	2.5 x 3.2 x 1.6
TCXO3225R-3.3V-LVCMOS	Quick Delivery	3.3	CMOS	10 to 1450	1	-40 to +85	2.5 x 3.2 x 1.6
TCXO3225R-2.5V-LVPECL	Quick Delivery	2.5	LVPECL	10 to 1450	1	-40 to +85	2.5 x 3.2 x 1.6
TCXO3225R-3.3V-LVPECL	Quick Delivery	3.3	LVPECL	10 to 1450	1	-40 to +85	2.5 x 3.2 x 1.6
TCXO3225R-2.5V-LVDS	Quick Delivery	2.5	LVDS	10 to 1450	1	-40 to +85	2.5 x 3.2 x 1.6
TCXO3225R-3.3V-LVDS	Quick Delivery	3.3	LVDS	10 to 1450	1	-40 to +85	2.5 x 3.2 x 1.6

## 10 to 1450 MHz Quick Delivery VCTCXO (Size: 5 x 7 mm)



Dynamic Engineers standard quick delivery VCTCXO can be delivered in 2-3 weeks for rapid prototypes development in:

- Standard 5 x 7mm FR4 motherboard 6-pad package
- Wide frequency range from 10 to 1450 MHz (up to 6<sup>th</sup> decimal place).
- CMOS, LVPECL or LVDS output

Model	Device Type	Power Supply	RF Output	Frequency Range (MHz)	Frequency Stability (ppm)	Operating Temperature (°C)	Package (mm)
TCXO7500AJ-2.5V-CMOS	Quick Delivery	2.5	CMOS	10 to 1450	1	-40 to +85	5 x 7 x 2.5
TCXO7500AJ-3.3V-CMOS	Quick Delivery	3.3	CMOS	10 to 1450	1	-40 to +85	5 x 7 x 2.5
TCXO7500AJ-2.5V-LVPECL	Quick Delivery	2.5	LVPECL	10 to 1450	1	-40 to +85	5 x 7 x 2.5
TCXO7500AJ-3.3V-LVPECL	Quick Delivery	3.3	LVPECL	10 to 1450	1	-40 to +85	5 x 7 x 2.5
TCXO7500AJ-2.5V-LVDS	Quick Delivery	2.5	LVDS	10 to 1450	1	-40 to +85	5 x 7 x 2.5
TCXO7500AJ-3.3V-LVDS	Quick Delivery	3.3	LVDS	10 to 1450	1	-40 to +85	5 x 7 x 2.5



Dynamic Engineers, Inc.  
**TCXO : Temperature Compensated**

## New Low-G TCXO : Temperature Compensated Crystal Oscillator (Less Than 0.5 ppb/G)

Dynamic Engineers continues to invest in advanced Low-G TCXO technology capable of performing to less than 0.5 ppb per G. Standard Low-G output frequencies currently available include 10, 16.32, 19.2, 20, and 25 MHz in both 3.2 x 5 mm and 5 x 7 mm configurations. Rugged environmental conditions such as mobile SATCOM with high shock and vibration is a prime example of an end use application for these TCXO devices. We also offer high performance TCXO which are designed to be used in 5G networks.

Model	Device Type	Power Supply	RF Output	Frequency Range (MHz)	Frequency Stability (ppm)	Operating Temperature (°C)	Package (mm)
TCXO911BTLG_series	5G	3.3	CMOS	50 to 125	1.0	-40 to +85	9.6 x 11.4 x 6.7
TCXO914BTLG_series	5G	3.3	Sinewave	50 to 150	0.5	-40 to +85	9 x 14 x 6.7
TCXO7500ZLGCS	SATCOM	3.3	Clipped Sine	10 to 25	0.5	-40 to +95	5 x 7 x 1.75
TCXO7500ZLGSQ	SATCOM	3.3	CMOS	10 to 25	0.5	-40 to +95	5 x 7 x 1.75
TCXO5300ZLGCS	SATCOM	3.3	Clipped Sine	10 to 25	0.5	-40 to +95	3.2 x 5 x 1.7
TCXO5300ZLGSQ	SATCOM	3.3	CMOS	10 to 25	0.5	-40 to +95	3.2 x 5 x 1.7

## Ultra-High Stability TCXO (Dual Compensation Process) : Temperature Compensated Crystal Oscillator

The Ultra-High Stability (UHS) TCXO family is based on Dynamic Engineers' proprietary compensation algorithms that take full advantage of precision crystal manufacturing process breakthroughs to deliver OCXO-like stability at a fraction of the power consumption.

Better than  $\pm 100$  ppb stability can be maintained over an extended temperature range of -40 to +105°C. Better than  $\pm 50$  ppb can be offered over -40 to +85°C.

High performance small cell base stations, mobile radio manpacks, and SATCOM reference clocks are ideal applications for this cutting edge TCXO design and process technology.



Model	Device Type	Power Supply	RF Output	Frequency Range (MHz)	Frequency Stability (ppm)	Operating Temperature (°C)	Package (mm)
TCXO2012S-UHS	High Stability	3.3	Clipped Sine	10 to 40	0.100	-40 to +105	12.8 x 20.4 x 7.8



Dynamic Engineers, Inc.  
**TCXO : Temperature Compensated**



## Expanded Selection of Large Package TCXO : Temperature Compensated Crystal Oscillator (1 to 800 MHz)

Dynamic Engineers offers an extensive lineup of legacy TCXO package configurations with a wide range of options such as:

- 9 x11 mm SMD to full 14-pin DIP leaded package of 13 x 20 mm
- 1 to 800 MHz operating frequencies
- Clipped sine, 50 ohm full sine wave, CMOS, LVDS, and LVPECL output

These TCXO's are designed for a diverse global customer base and application spectrum. Standard technologies such as phase noise, short term stability, or non-standard frequencies can be tailored to customer specific requirements. We provide value to our customers by offering the latest in both technology and design, as well as legacy packages which may no longer be available from our competitors.

Model	Device Type	Power Supply	RF Output	Frequency Range (MHz)	Frequency Stability (ppm)	Operating Temperature (°C)	Package (mm)
TCXO1313LCS1	Standard	3.3	Clipped Sine	10 to 50	0.5	-40 to +85	12.7 x 12.7 x 5.1
TCXO1313LCS2	Standard	5	Clipped Sine	10 to 50	0.5	-40 to +85	12.7 x 12.7 x 5.1
TCXO1313LS1	Standard	3.3	Sine	10 to 50	0.5	-40 to +85	12.7 x 12.7 x 5.1
TCXO1313LS2	Standard	5	Sine	10 to 50	0.5	-40 to +85	12.7 x 12.7 x 5.1
TCXO1313LSQ1	Standard	3.3	CMOS	6 to 190	0.5	-40 to +85	12.7 x 12.7 x 5.1
TCXO1313LSQ2	Standard	5	CMOS	6 to 190	0.5	-40 to +85	12.7 x 12.7 x 5.1
TCXO1313LP1	Standard	3.3	LVPECL	1 to 800	0.5	-40 to +85	12.7 x 12.7 x 5.1
TCXO1313LP2	Standard	5	LVPECL	1 to 800	0.5	-40 to +85	12.7 x 12.7 x 5.1
TCXO1313LD1	Standard	3.3	LVDS	1 to 800	0.5	-40 to +85	12.7 x 12.7 x 5.1
TCXO1313LD2	Standard	5	LVDS	1 to 800	0.5	-40 to +85	12.7 x 12.7 x 5.1
TCXO2013LCS1	Standard	3.3	Clipped Sine	6 to 190	0.5	-40 to +85	13.1 x 20.7 x 7.5
TCXO2013LCS2	Standard	5	Clipped Sine	6 to 190	0.5	-40 to +85	13.1 x 20.7 x 7.5
TCXO2013LS1	Standard	3.3	Sine	6 to 190	0.5	-40 to +85	13.1 x 20.7 x 7.5
TCXO2013LS2	Standard	5	Sine	6 to 190	0.5	-40 to +85	13.1 x 20.7 x 7.5
TCXO2013LSQ1	Standard	3.3	CMOS	6 to 190	0.5	-40 to +85	13.1 x 20.7 x 7.5
TCXO2013LSQ2	Standard	5	CMOS	6 to 190	0.5	-40 to +85	13.1 x 20.7 x 7.5
TCXO2013LP1	Standard	3.3	LVPECL	1 to 800	0.5	-40 to +85	13.1 x 20.7 x 7.5
TCXO2013LP2	Standard	5	LVPECL	1 to 800	0.5	-40 to +85	13.1 x 20.7 x 7.5
TCXO2013LD1	Standard	3.3	LVDS	1 to 800	0.5	-40 to +85	13.1 x 20.7 x 7.5
TCXO2013LD2	Standard	5	LVDS	1 to 800	0.5	-40 to +85	13.1 x 20.7 x 7.5
TCXO119ZCST1	Standard	3	Clipped Sine	9.6 to 50	1	-40 to +85	9.6 x 11.4 x 1.9
TCXO119ZCST2	Standard	3.3	Clipped Sine	9.6 to 50	1	-40 to +85	9.6 x 11.4 x 1.9
TCXO119ZCST3	Standard	5	Clipped Sine	9.6 to 50	1	-40 to +85	9.6 x 11.4 x 1.9
TCXO119ZCLK1	Standard	3	CMOS	9.6 to 50	1	-40 to +85	9.6 x 11.4 x 1.9
TCXO119ZCLK2	Standard	3.3	CMOS	9.6 to 50	1	-40 to +85	9.6 x 11.4 x 1.9
TCXO119ZCLK3	Standard	5	CMOS	9.6 to 50	1	-40 to +85	9.6 x 11.4 x 1.9
TCXO914ZCLK1	Standard	3.3	CMOS	5 to 200	0.5	-40 to +85	9 x 14 x 5
TCXO914ZCLK2	Standard	5	CMOS	5 to 200	0.5	-40 to +85	9 x 14 x 5
TCXO2013ZS1	Standard	3.3	Sine	10 to 200	0.5	-40 to +85	13 x 20 x 6
TCXO2013ZS2	Standard	5	Sine	10 to 200	0.5	-40 to +85	13 x 20 x 6



Dynamic Engineers, Inc.  
**TCXO : Temperature Compensated**

**CONTACT US :**  
[www.DynamicEngineers.com](http://www.DynamicEngineers.com)  
[Sales@DynamicEngineers.com](mailto:Sales@DynamicEngineers.com)  
 TEL: (+1) 281-870-8822

## Extended Temperature Range XO : Clock Crystal Oscillator (-55 to +125°C)

Dynamic Engineers' state-of-the-art extended temperature XO, the XO3225S series, is designed for harsh environments such as oil drilling, geothermal, or industrial instrumentation, with features like:

- Extended operating temperature range from -55 to +125°C
- Low jitter and phase noise typical at 25 picoseconds Pk-Pk period jitter
- 1.8V, 2.5V or 3.3V voltage options
- Tight symmetry of 45% to 55% available

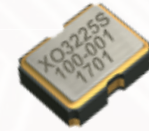

Model	Device Type	Power Supply	RF Output	Frequency Range (MHz)	Frequency Stability (ppm)	Operating Temperature (°C)	Package (mm)
XO3225S-ET	Extended Temp	1.8, 2.5, 3.3	CMOS	1.25 to 100	50	-55 to +125	2.5 x 3.2 x 1
XO2520S-ET	Extended Temp	1.8, 2.5, 3.3	CMOS	1.25 to 100	50	-55 to +125	2 x 2.5 x 1
XO3225SLP1-ET	Extended Temp	2.5	LVPECL	10 to 250	50	-40 to +125	2.5 x 3.2 x 0.9
XO3225SLP2-ET	Extended Temp	3.3	LVPECL	10 to 250	50	-40 to +125	2.5 x 3.2 x 0.9
XO3225SLD1-ET	Extended Temp	2.5	LVDS	10 to 250	50	-40 to +125	2.5 x 3.2 x 0.9
XO3225SLD2-ET	Extended Temp	3.3	LVDS	10 to 250	50	-40 to +125	2.5 x 3.2 x 0.9

## Extreme Temperature Range XO : Clock Crystal Oscillator (-100 to +300°C)

Dynamic Engineers strives to provide High-Reliability solutions to meet all XO needs. Our extreme temperature XOs are capable of operating in the range of -100 to +300°C as well as being resistant to shock and vibration for use in extreme temperature environments. They are available in a broad selection of supply voltages, frequency ranges, and packaging options.



Model	Device Type	Power Supply	RF Output	Frequency Range (MHz)	Frequency Stability (ppm)	Operating Temperature (°C)	Package (mm)
ETXO3225I	Extreme Temp	1.8 to 5.5	CMOS	0.032768	300	-55 to +150	3.2 x 2.5 SMD
ETXO7500I	Extreme Temp	1.8 to 5.5	CMOS	80 (max)	60 to 250	-100 to +240	5.0 x 7.2 SMD
ETXOI-A	Extreme Temp	1.2 to 18	CMOS	110 (max)	100, 250, 300	-100 to +300	12.95 x 12.95 Half-Dip Leaded
ETXOI-B	Extreme Temp	1.2 to 18	CMOS	110 (max)	100, 250, 300	-100 to +300	12.83 x 22.35 Full-Dip Leaded
ETXOI-C	Extreme Temp	1.2 to 18	CMOS	110 (max)	100, 250, 300	-100 to +300	6.60 height 8-pin TO-5 leaded
ETXOI-D	Extreme Temp	1.2 to 18	CMOS	110 (max)	100, 250, 300	-100 to +300	4.45 height 8-pin TO-5 leaded



Dynamic Engineers, Inc.  
**XO : Clock Crystal Oscillator**

**CONTACT US :**  
www.DynamicEngineers.com  
Sales@DynamicEngineers.com  
TEL: (+1) 281-870-8822

## Lowest Jitter XO (Integrated Phase Jitter in Femto-seconds)

Dynamic Engineer's outstanding clock oscillator technology incorporates the latest low noise oscillator IC architecture, and advanced low noise crystal processing breakthroughs to deliver:

- RMS phase jitter as low as 48 femto-seconds integrated over 12 KHz to 20 MHz
- Phase noise performance of -166 dBc/Hz @ 100 KHz and -171 dBc/Hz @ 1 MHz offset

This extreme low phase jitter XO is best suited to serve as the clock reference for high performance D/A conversion in the highest quality digital audio systems where outstanding timing resolution is key.



Model	Device Type	Power Supply	RF Output	Frequency Range (MHz)	Frequency Stability (ppm)	Operating Temperature (°C)	Package (mm)
XO3225AJSQ1	Low Phase Noise	1.8	CMOS	10 to 50	25	-40 to +85	2.5 x 3.2 x 1
XO3225AJSQ2	Low Phase Noise	2.5	CMOS	10 to 50	25	-40 to +85	2.5 x 3.2 x 1
XO3225AJSQ3	Low Phase Noise	3.3	CMOS	10 to 50	25	-40 to +85	2.5 x 3.2 x 1
XO5300AJSQ1	Low Phase Noise	1.8	CMOS	10 to 50	25	-40 to +85	3.2 x 5 x 1.2
XO5300AJSQ2	Low Phase Noise	2.5	CMOS	10 to 50	25	-40 to +85	3.2 x 5 x 1.2
XO5300AJSQ3	Low Phase Noise	3.3	CMOS	10 to 50	25	-40 to +85	3.2 x 5 x 1.2
XO7500AJSQ1	Low Phase Noise	1.8	CMOS	10 to 50	25	-40 to +85	5 x 7 x 1.4
XO7500AJSQ2	Low Phase Noise	2.5	CMOS	10 to 50	25	-40 to +85	5 x 7 x 1.4
XO7500AJSQ3	Low Phase Noise	3.3	CMOS	10 to 50	25	-40 to +85	5 x 7 x 1.4

## Expanded Selection of Standard Package XO

Dynamic Engineers' state-of-the-art XO pushes the technology envelope in clock oscillator technology by offering supply voltages down to 1.8V, and package sizes as small as 1.6 x 2.0 mm. Ultra-compact quartz crystal resonator blank research continues to allow further reductions in overall package size without sacrificing long term reliability.



Model	Device Type	Power Supply	RF Output	Frequency Range (MHz)	Frequency Stability (ppm)	Operating Temperature (°C)	Package (mm)
XO2016Z1	Standard	1.8	CMOS	0.75 to 80	25	-40 to +85	1.6 x 2 x 1
XO2016Z2	Standard	2.5	CMOS	0.75 to 80	25	-40 to +85	1.6 x 2 x 1
XO2016Z3	Standard	3.3	CMOS	0.75 to 80	25	-40 to +85	1.6 x 2 x 1
XO2520Z1	Standard	1.8	CMOS	1 to 80	25	-40 to +85	2 x 2.5 x 1
XO2520Z2	Standard	2.5	CMOS	1 to 80	25	-40 to +85	2 x 2.5 x 1
XO2520Z3	Standard	3.3	CMOS	1 to 80	25	-40 to +85	2 x 2.5 x 1
XO3225Z1	Standard	1.8	CMOS	0.03 to 133	10	-40 to +85	2.5 x 3.2 x 1.2
XO3225Z1	Standard	2.5	CMOS	0.03 to 133	10	-40 to +85	2.5 x 3.2 x 1.2
XO3225Z1	Standard	3.3	CMOS	0.03 to 133	10	-40 to +85	2.5 x 3.2 x 1.2
XO5300ZLP1	Standard	2.5	LVPECL	20 to 212.5	50	-40 to +85	3.2 x 5 x 1.3
XO5300ZLP2	Standard	3.3	LVPECL	20 to 212.5	50	-40 to +85	3.2 x 5 x 1.3
XO5300ZLD1	Standard	2.5	LVDS	20 to 212.5	50	-40 to +85	3.2 x 5 x 1.3
XO5300ZLD2	Standard	3.3	LVDS	20 to 212.5	50	-40 to +85	3.2 x 5 x 1.3



Dynamic Engineers, Inc.  
**XO : Clock Crystal Oscillator**

## Lowest Jitter VCXO : Voltage Controlled Crystal Oscillator

Dynamic Engineers continues to invest in new IC technology in order to offer lowest jitter performing VCXO devices in smaller package footprints. Our line of differential output VCXOs comes in an 8-pad 3.2 x 5.0 mm ceramic carrier. World class integrated phase jitter can be achieved for LVDS and LVPECL outputs up to an operating frequency of 2.1 GHz.

Model	Device Type	Power Supply	RF Output	Frequency Range (MHz)	Frequency Stability (ppm)	Operating Temperature (°C)	Package (mm)
VCXO5300AJLP1	Low Phase Noise	2.5	LVPECL	15 to 2100	25	-40 to +85	3.2 x 5 x 1.3
VCXO5300AJLP2	Low Phase Noise	3.3	LVPECL	15 to 2100	25	-40 to +85	3.2 x 5 x 1.3
VCXO5300AJLD1	Low Phase Noise	2.5	LVDS	15 to 2100	25	-40 to +85	3.2 x 5 x 1.3
VCXO5300AJLD2	Low Phase Noise	3.3	LVDS	15 to 2100	25	-40 to +85	3.2 x 5 x 1.3

## SMA Output Connector VCXO : Voltage Controlled Crystal Oscillator

Dynamic Engineers offers SMA Output Connector VCXOs with ruggedized package design for harsh environment microwave Local Oscillator (LO) modules up to 1500 MHz. One of our designs offers very wide pulling of  $\pm 1500$  ppm minimum by utilizing special crystal materials with unique properties.

Model	Device Type	Power Supply	RF Output	Frequency Range (MHz)	Frequency Stability (ppm)	Electronic Adjustment (ppm)	Package (mm)
VCXO5440LULN1-SMA	Low Phase Noise	12	Sine	300 to 1300	50	-40 to +85	40 x 54 x 19
VCXO5440LWP-SMA	Wide Pull	12	Sine	500 to 1500	20	-40 to +85	40 x 54 x 19

## Expanded Selection of Standard Package VCXO : Voltage Controlled Crystal Oscillator

Dynamic Engineers continues to enhance its VCXO portfolio with upgraded performance in smaller packages.

Model	Device Type	Power Supply	RF Output	Frequency Range (MHz)	Frequency Stability (ppm)	Operating Temperature (°C)	Package (mm)
VCXO5300ZLP1	Standard	2.5	LVPECL	60 to 175	50	-40 to +85	3.2 x 5 x 1.3
VCXO5300ZLP2	Standard	3.3	LVPECL	60 to 175	50	-40 to +85	3.2 x 5 x 1.3
VCXO5300ZLD1	Standard	2.5	LVDS	60 to 175	50	-40 to +85	3.2 x 5 x 1.3
VCXO5300ZLD2	Standard	3.3	LVDS	60 to 175	50	-40 to +85	3.2 x 5 x 1.3
VCXO914ZLP1	Standard	2.5	LVPECL	100 to 800	50	-40 to +85	9 x 14 x 5.5
VCXO914ZLP2	Standard	3.3	LVPECL	100 to 800	50	-40 to +85	9 x 14 x 5.5
VCXO914ZLD1	Standard	2.5	LVDS	100 to 800	50	-40 to +85	9 x 14 x 5.5
VCXO914ZLD2	Standard	3.3	LVDS	100 to 800	50	-40 to +85	9 x 14 x 5.5



## Custom GHz Frequency Source Modules

Manufacturers or users of phased array antenna systems must be able to set up their test systems using phase coherent Local Oscillators (LO) for proper measurements and antenna simulations. DEI custom GHz frequency source modules can be used to test and simulate multiple high frequency receiver systems, where the receivers must have an equivalent LO source instead of independent LO sources.

Unique features of our GHz frequency source modules include:

- Internal ultra-low phase noise reference OCXO
- Customizable frequency source
- 1 direct OCXO output and 2 user definable outputs (multiplied / synthesized)
- Phase coherent output



### For the OCXO6060L platform:

- RF1 ranges from 50 to 160 MHz
- RF2 ranges from 600 to 1600 MHz
- RF3 ranges from 1200 to 3200 MHz

### For the PLOCXO7070L platform:

- RF1 ranges from 50 to 160 MHz
- RF2 ranges from 300 to 1300 MHz
- RF3 ranges from 300 to 3000 MHz
- The PLOCXO7070L phase locks to an external FREF (RF IN)

## Phase Locked PLXOs & GHz TCXOs

### PLXO5050L:

- Frequency Range: 3 to 12 GHz
- Phase Noise (typ): -120 dBc/Hz at 100 KHz offset
- Output Type: Sine Wave



### TCXO5440L:

- Frequency Range: 300 to 1300 MHz
- Frequency Stability: up to  $\pm 0.5$  ppm over -40 to +85°C
- Output Type: Sine Wave

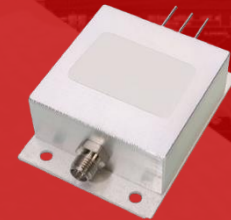

## Low Profile 21.4 MHz Bandpass Crystal Filter Designs for Next Generation Mobile Radio Architectures

Dynamic Engineers introduces next generation crystal filter products for new wide area network mobile radio architectures. Device height has been reduced from 13 mm in legacy designs to less than 6 mm maximum. This dramatic height reduction has been achieved by utilizing cutting edge crystal technology, and advance miniature trimmer capacitor and toroid materials for impedance matching lumped elements.

- 3 dB bandwidths can range from  $\pm 25$  KHz minimum to  $\pm 35$  KHz minimum.
- 40 to 60 dB stopbands range from 280 KHz to 700 KHz total.
- Low pass band ripple of 0.5 to 1 dB translates into outstanding Group Delay Variation of less than 1.5 micro-seconds.
- Outstanding crystal matching supported by precise computer simulation enable 60 dB attenuation on all spurious outside the stop band

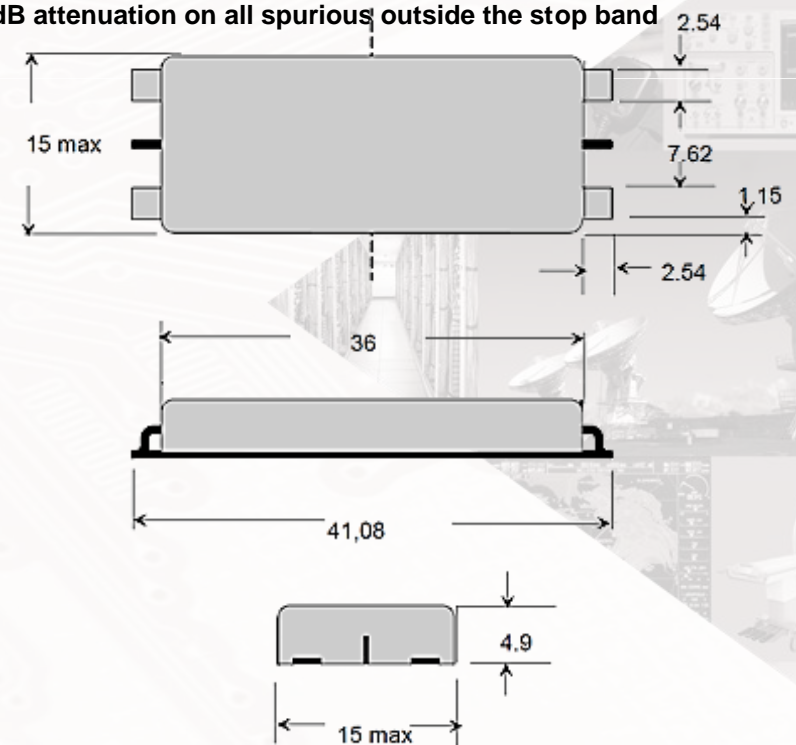
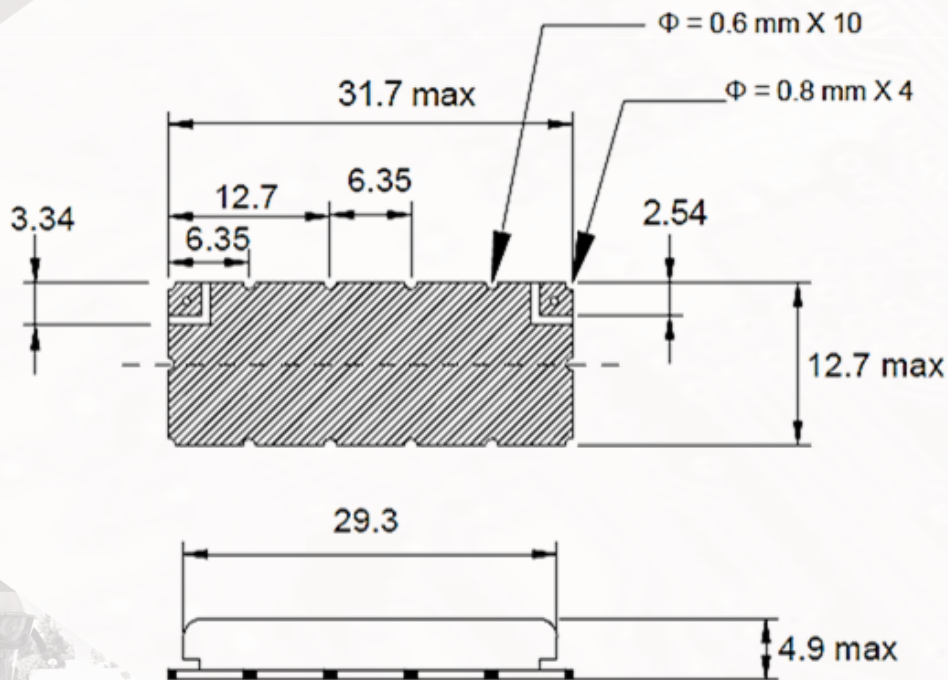

Unit: mm  
1mm=0.0394inch



Dynamic Engineers, Inc.  
**Bandpass Crystal Filter**

## Custom LC Filter Design (Frequencies up to 6 GHz)

Dynamic Engineers offers a wide selection of LC filters up to 6 GHz in custom leaded or surface mount packages. The most critical component of the LC filter design, the filter coils, are assembled by hand internally. The combination of critical lumped element and filter manufacturing in the same facility enables us to meet stringent global quality and reliability standards for LC filter performance.

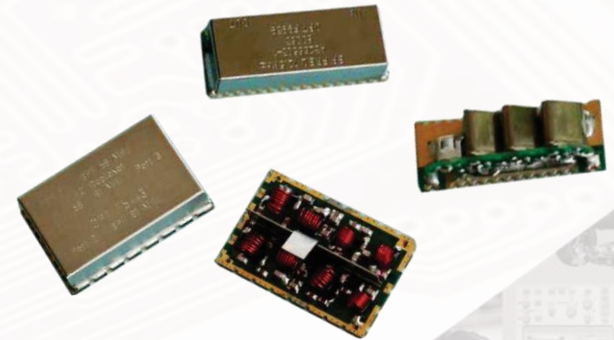

Model	Center Frequency (MHz)	Passband (+/- MHz)	Passband Attenuation (dB)	Stopband (+/- MHz)	Stopband Attenuation (dB)	Package (mm)
LCF1000	21.400	0.500	3	2	60	44.5 x 16.0
LCF1001	113.000	5	3	78 to 165	50	36.8 x 12.7
LCF1002	220.000	25	0.6	280 to 1000	40	22.9 x 10.2
LCF1003	125.000	5	3	250	60	22.9 x 10.2
LCF1005	400 to 470	400 to 470	0.5	800 to 900	50	135.0 x 25.0

**Note:** Wide Variety of custom package sizes available

## Tunable LC Filter (Frequencies from 225 to 512 MHz)

The TLCF-225-512MHz-A is a tunable LC filter module that can reduce co-site interference in the transmitting function and increase receiver sensitivity by filtering out of band unwanted signals. Standard technologies such as frequency ranges and bandwidths can be tailored to customer specific requirements upon request.

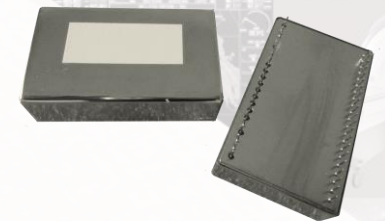

- Tuning Speed: Less than 10  $\mu$ s maximum
- Ideal for use in portable small cell and radar applications
- Frequency Range: 225 MHz to 512 MHz in 250 channels
- Operating Temperature: -45 to +80°C



## Filter Bank Module (Frequencies from 30 to 512 MHz)

Dynamic Engineers' comprehensive line of Filter Bank Modules, the BFM3364 series, operate in a frequency range of 30 to 512 MHz which can be used both in Transmitting and Receiving mode. In Transmitting mode, the BFM3364 works as a 6 Channel Harmonic Filter where each band is selected automatically with a PIN Diode switch. In Receiving mode the module operates as a Gain Block providing High Linearity and Low Noise operation.

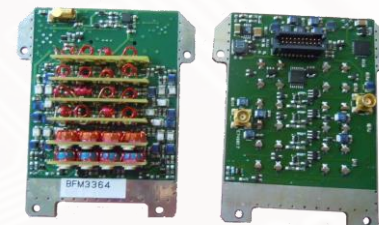

Frequency Range	30 to 512 MHz					
Frequency Bands	CH1 : 30-50 MHz CH2 : 50-80 MHz CH3 : 80-140 MHz CH4 : 140-227 MHz CH5 : 227-400 MHz CH6 : 400-512 MHz					
$Z_{in} = Z_{out}$	50 $\Omega$					
Insertion Loss	2.5 db max. 1.8 db typical					
VSWR	1.5 : 1					
Attenuation (reference is made to $F_{min}$ of each selected channel) 2* $F_{min}$ 3* $F_{min}$ 4* $F_{min}$ 5* $F_{min}$	CH1	CH2	CH3	CH4	CH5	CH6
	> 24 db	> 27 db	> 26 db	> 28 db	> 24 db	> 35 db
	> 33 db	> 45 db	> 43 db	> 46 db	> 43 db	> 51 db
	> 40 db	> 50 db	> 45 db	> 50 db	> 41 db	> 56 db
	> 45 db	> 50 db	> 45 db	> 50 db	> 48 db	> 45 db
RF Power Handling	8 W (10 W max.)					
Switch Time	Switch time 50 $\mu$ sec max.					
Operating Temperature Range	-30 to +60°C					
Supply Voltage: V1 V2	3.3 V (5 V max.) 18 to 20 V (25 V max.)					
DC Current: I1 ( $I_{cc}$ at V1) I2 ( $I_{cc}$ at V2)	280 mA 10 mA					





## VCO : Voltage Controlled Oscillator

Dynamic Engineers offers a wide array of VCO designs in the industry standard 12.7 x 12.7 mm footprint. Critical performance parameters such as tuning sensitivity (MHz/volt), and phase noise can be measured as a function of operating temperature and min/max. tuning voltage. Customer specific requirements are also welcome if a matching device cannot be found amid our extensive design offerings.

Model	Frequency Range (MHz)	Power Output (dBm)	Tuning Voltage (Vdc)	Tuning Sensitivity (MHz/V)	2 <sup>nd</sup> Harmonic (dBc)	Supply Voltage (Vdc)	Current (mA)	Phase Noise @ 10 kHz (dBc/Hz)
VCO50-100	50 to 100	9.5	1-15	4.5	-18	5	20	-109
VCO135-185	135 to 185	5	1.5-10	9	-18	11	20	-110
VCO200-400	200 to 400	11	1-16	16	-10	5	18	-104
VCO376-410	376 to 410	3	0.5-4.5	13	-15	5	15	-118
VCO540-560	540 to 560	2.5	1-4	14	-13	5	16	-110
VCO736-760	736 to 760	0	0.5-4.5	13	-20	5	25	-115
VCO800-956	800 to 956	3	0.4 - 4.7	47	-18	4.3	25	-105
VCO1000-1100	1000 to 1100	11	0.5-4.5	37	-20	5	29	-112
VCO1248	1248	7	0.5-4.5	3.5	-20	5	24	-125
VCO1330-1350	1330 to 1350	5	0.5-5.0	35	-27	5	21	-100
VCO1400-2400	1400 to 2400	3	1-16	90	-20	5	21	-98
VCO1510-1650	1510 to 1650	0	1.5-12	24	-25	8	15	-107
VCO1640-1700	1640 to 1700	2.5	0.5-4.5	30	-21	5	23	-111
VCO1700-1800	1700 to 1800	7	0.5-4.5	35	-15	5	20	-110
VCO1800-1900	1800 to 1900	0	0.5-4.5	40	-30	5	27	-107
VCO1850-2050	1850 to 2050	5	1-14	30	-18	6	27	-107
VCO1950-2350	1950 to 2350	7	0-10	60	-15	10	17	-101
VCO2000	2000	6	0.5-4.5	6	-25	6	28	-122
VCO2100-2200	2100 to 2200	0	0.5-4.5	36	-20	5	26	-106
VCO2137-2498	2137 to 2498	9	1-20	60	-10	10	40	-106
VCO2200-2300	2200 to 2300	0	0.5-4.5	36	-20	5	26	-106
VCO2310	2310	7	0.5-4.5	7	-15	6	28	-120
VCO2436-2590	2436 to 2590	2	1-11	19	-15	12.5	29	-112
VCO2525-2800	2525 to 2800	5	1-12	35	-20	6	27	-107
VCO2580	2580	7	1-10	4	-20	8	27	-120
VCO2652-3218	2652 to 3218	0	3-16	55	-15	5	24	-98
VCO2800-3400	2800 to 3400	7	2-20	65	-10	8	31	-85
VCO2960-3032	2960 to 3032	3	0.5-4.5	33	-20	5	27	-105
VCO3200	3200	6	1-10	7	-25	8	25	-114
VCO4680-4720	4680 to 4720	5	0-10	9	-36	5	20	-100



## NOTES:

## Contact Us

### Headquarters in Houston, Texas

**Phone:** (+1) 281-870-8822  
**Email:** Sales@DynamicEngineers.com  
**Address:** 2550 Gray Falls Dr., Houston, TX, 77077



### **DISCLAIMER:**

*This brochure represents a sampling of available models. Please consult our sales department or visit us online for more detailed and complete listings of our products. All products are subject to US Export Regulations.*



Dynamic Engineers, Inc.  
**Contact Info, Notes, Disclaimer**

**CONTACT US :**  
[www.DynamicEngineers.com](http://www.DynamicEngineers.com)  
[Sales@DynamicEngineers.com](mailto:Sales@DynamicEngineers.com)  
TEL: (+1) 281-870-8822