



Features and Benefits

Frequency range: 32.768KHz
Supply voltage: 1.8V
Current: 1.8uA Max.
Frequency stability vs. temperature: ±25PPM
Aging: ±3PPM per year
Operating temperature: -20°C to +70°C
Size: 2.5x2.0x0.81 mm

Typical Applications

RTC Reference Clock
Wearable device
Sport Video Cams
Ultra-small Notebook PC
Mobile Phones
Health and Wellness Monitors

Description

XO2520BM-ULP-32.768KHz-112 is the ultra-low power crystal oscillator. The power consumption can less than 1.8uA. It can be widely used in the low power consumption applications.

Mechanical Drawing & Pin Connections

Drawing No: MD220021-1

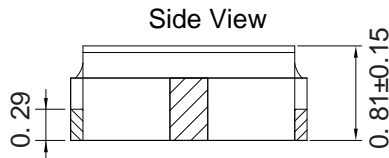
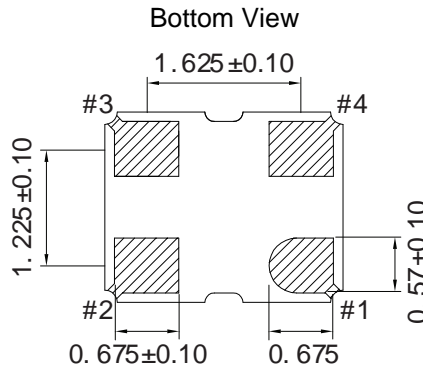
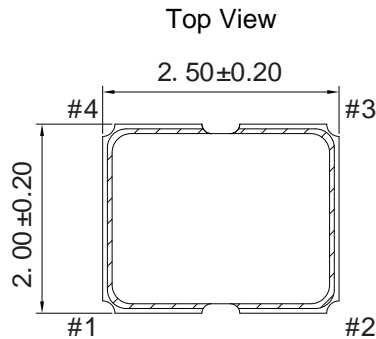

Pin#	Function
1	NC
2	GND
3	Output
4	Vcc

Unit in mm
1mm = 0.0394 inches

Recommended Soldering Pattern

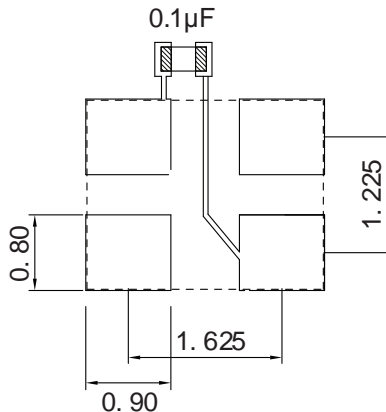

To ensure optimal oscillator performance, place a by-pass capacitor of 0.1uF as close to the part as possible between Vcc and GND PAD



Specifications

Oscillator Specification	Sym	Condition	Value			Unit	Note
			Min.	Typ.	Max.		
Operational Frequency	f ₀			32.768		KHz	
RF Output							
Output Level High			90%V _{cc}			V	
Output Level Low					10%V _{cc}	V	
Rise & Fall Time		@ 10%-90%			10	ns	
Duty Cycle			45		55	%	
Startup Time					8	ms	
Power Supply							
Voltage	V _{cc}	±5%		1.8		V	
Current				1.4	1.8	uA	
Frequency Stability							
Tolerance		@+25°C, 3days average			±10	ppm	
Versus Temperature		@-20°C to +70°C with reference to +25°C, 3day average			±25	ppm	
Versus Aging@+25°C		1 st year			±3.0	ppm	
Environmental Conditions							
Operating temperature range		-20°C to +70°C					
Storage temperature range		-55°C to +125 °C					